

Data Sheet

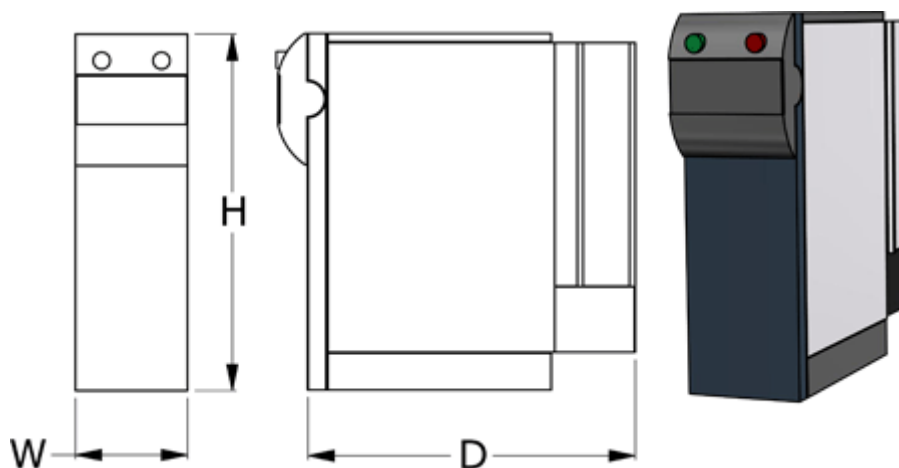

Article number: 1080201011000
Description: Servocontroller ACU201-01-FA
0,25 kW 1,6A 1x230V IP20

Measures



D = 175
H = 190
W = 60
Weight = 1.2